

# XPS 13 9315 2-in-1

## Setup and Specifications



## Notes, cautions, and warnings

 **NOTE:** A NOTE indicates important information that helps you make better use of your product.

 **CAUTION:** A CAUTION indicates either potential damage to hardware or loss of data and tells you how to avoid the problem.

 **WARNING:** A WARNING indicates a potential for property damage, personal injury, or death.

# Contents

<b>Chapter 1: Set up your XPS 13 9315 2-in-1.....</b>	<b>4</b>
Attach the XPS Folio keyboard.....	6
Connect your XPS Stylus for the first time.....	7
<b>Chapter 2: Views of XPS 13 9315 2-in-1.....</b>	<b>9</b>
Front.....	9
Back.....	10
Right.....	10
Left.....	11
Top.....	11
Bottom.....	12
<b>Chapter 3: Specifications of XPS 13 9315 2-in-1.....</b>	<b>13</b>
Dimensions and weight.....	13
Processor.....	13
Chipset.....	14
Operating system.....	14
Memory.....	15
External ports.....	15
Internal slots.....	15
WLAN module.....	16
WWAN module.....	16
Audio.....	17
Storage.....	17
Camera.....	18
Power adapter.....	18
Battery.....	19
Display.....	20
GPU—Integrated.....	21
Fingerprint reader.....	21
Sensors.....	21
Operating and storage environment.....	22
Hardware security.....	22
Keyboard.....	22
Touchpad.....	23
<b>Chapter 4: Low blue light.....</b>	<b>24</b>
<b>Chapter 5: Keyboard shortcuts of XPS Folio keyboard.....</b>	<b>25</b>
<b>Chapter 6: Getting help and contacting Dell.....</b>	<b>27</b>

# Set up your XPS 13 9315 2-in-1

**NOTE:** The images in this document may differ from your computer depending on the configuration you ordered.

1. For computers with WWAN support, insert the nano-SIM card into the nano-SIM card slot on your computer as shown below. Skip to the next step if your computer does not have a nano-SIM card slot.

**NOTE:** WWAN support will be available at a later date.

**NOTE:** For more information on how to setup the nano-SIM card and connect to a cellular network, go to [www.dell.com/support](http://www.dell.com/support) and enter the model number in **Search support**. Refer to the *SIM/eSIM Setup Guide for Windows* available with your product documentation.

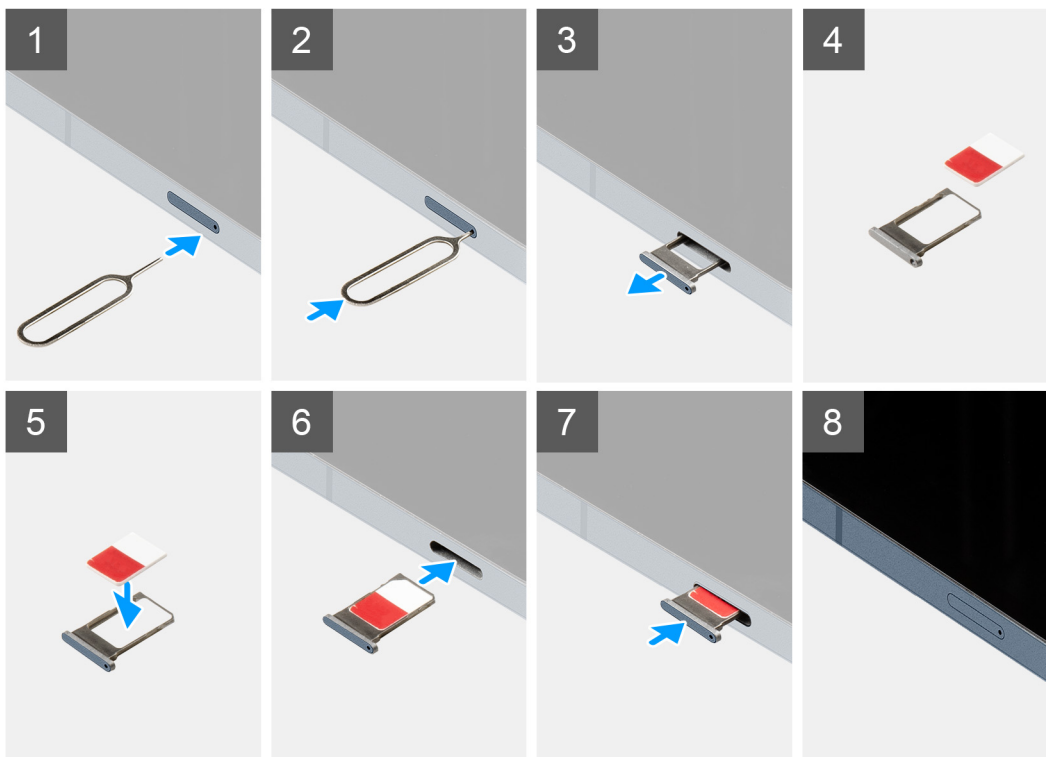

2. Connect the power adapter to either of the Thunderbolt 4.0 ports and press the power button.



**NOTE:** The battery may go into power-saving mode during shipment to conserve charge on the battery. Ensure that the power adapter is connected to your computer when it is turned on for the first time.



3. Finish Windows setup.

Follow the on-screen instructions to complete the setup. When setting up, Dell recommends that you:



- Connect to a network for Windows updates.
  - NOTE:** If connecting to a secured wireless network, enter the password for the wireless network access when prompted.
- If connected to the Internet, sign in with or create a Microsoft account. If not connected to the Internet, create an offline account.
- On the **Support and Protection** screen, enter your contact details.

4. Locate and use Dell apps from the Windows Start menu—Recommended.

**Table 1. Locate Dell apps**

Resources	Description
	<p><b>My Dell</b></p> <p>Centralized location for key Dell applications, help articles, and other important information about your computer. It also notifies you about the warranty status, recommended accessories, and software updates if available.</p>
	<p><b>SupportAssist</b></p> <p>SupportAssist proactively and predictively identifies hardware and software issues on your computer and automates the engagement process with Dell Technical support. It addresses performance and stabilization issues, prevents security threats, monitors, and detects hardware failures. For more information, see <i>SupportAssist for Home PCs User's Guide</i> at <a href="http://www.dell.com/serviceabilitytools">www.dell.com/serviceabilitytools</a>. Click <b>SupportAssist</b> and then, click <b>SupportAssist for Home PCs</b>.</p> <p><b>NOTE:</b> In SupportAssist, click the warranty expiry date to renew or upgrade your warranty.</p>

**Table 1. Locate Dell apps (continued)**

Resources	Description
	<b>Dell Update</b> Updates your computer with critical fixes and latest device drivers as they become available. For more information on using Dell Update, search in the Knowledge Base Resource at <a href="http://www.dell.com/support">www.dell.com/support</a> .
	<b>Dell Digital Delivery</b> Download software applications, which are purchased but not preinstalled on your computer. For more information on using Dell Digital Delivery, search in the Knowledge Base Resource at <a href="http://www.dell.com/support">www.dell.com/support</a> .

## Attach the XPS Folio keyboard

**NOTE:** These instructions apply only if you are connecting your computer to an XPS Folio keyboard (sold separately).

1. Lower the computer onto the XPS Folio keyboard as shown. Ensure the pogo connector on the computer and keyboard are aligned and firmly attached.

**NOTE:** The XPS Folio keyboard is powered by your computer when attached. It does not need to be charged separately.

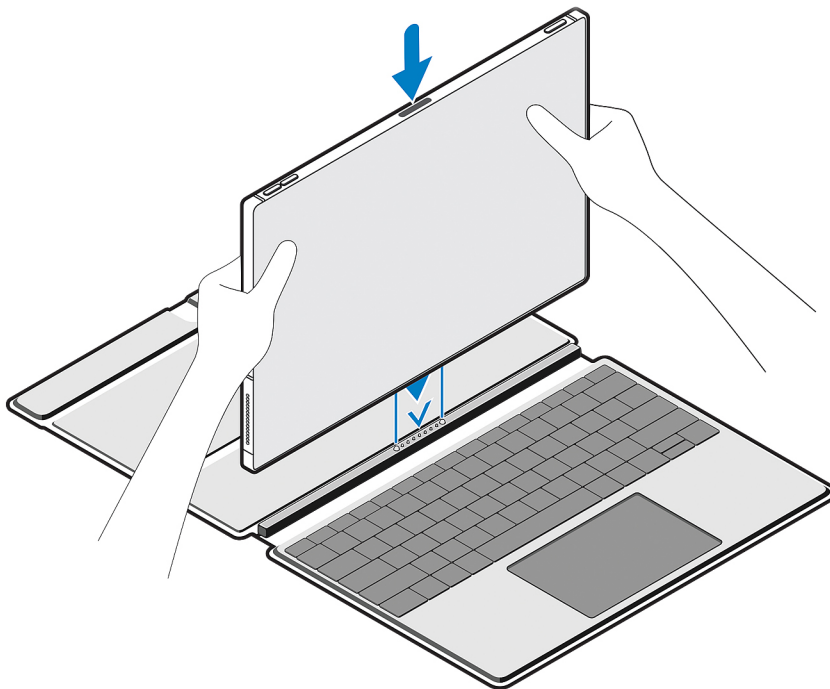

2. Adjust the flap on the XPS Folio keyboard into a preferred position.

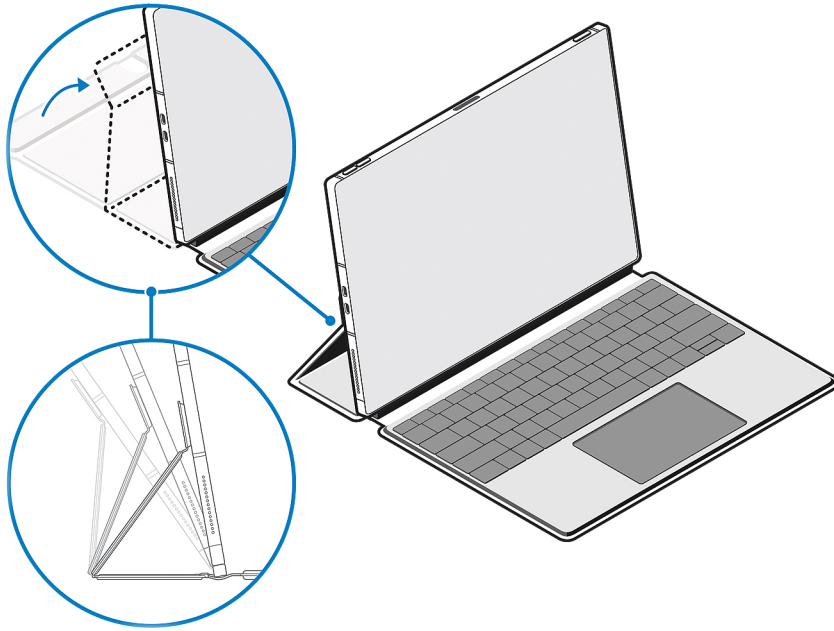

**i** **NOTE:** For a stable and comfortable typing experience, place the computer on a flat surface when in use.

**i** **NOTE:** Use a damp cloth or wet wipes with 50% alcohol or less to clean off any dust on the XPS Folio keyboard.

## Connect your XPS Stylus for the first time

**i** **NOTE:** These instructions apply only if you are connecting an XPS Stylus (sold separately) to your computer.

1. Place the flat side of the XPS Stylus on the top of the computer, where the charging area is located—the pen nib can face either the left or the right.

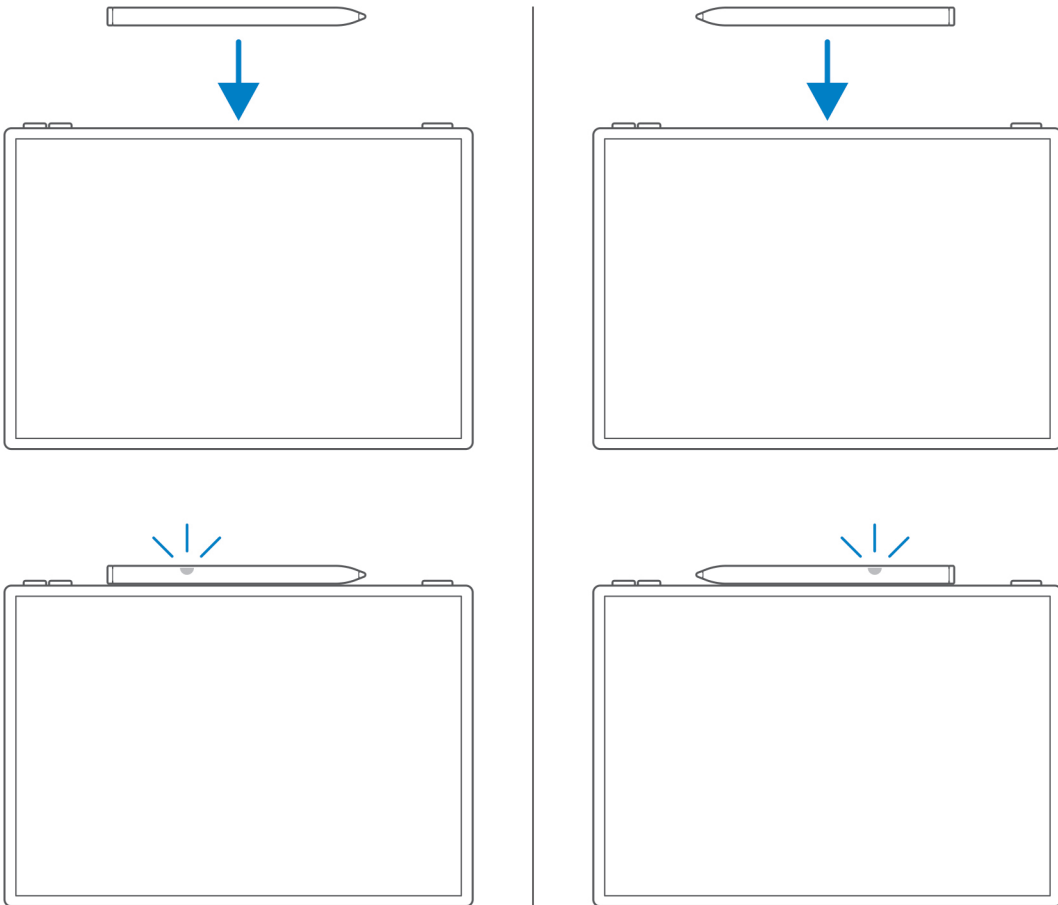

2. A pop-up window appears on your computer's display, prompting you to pair your XPS Stylus to your computer using the Bluetooth connection. Tap or click **Connect** to initiate pairing.

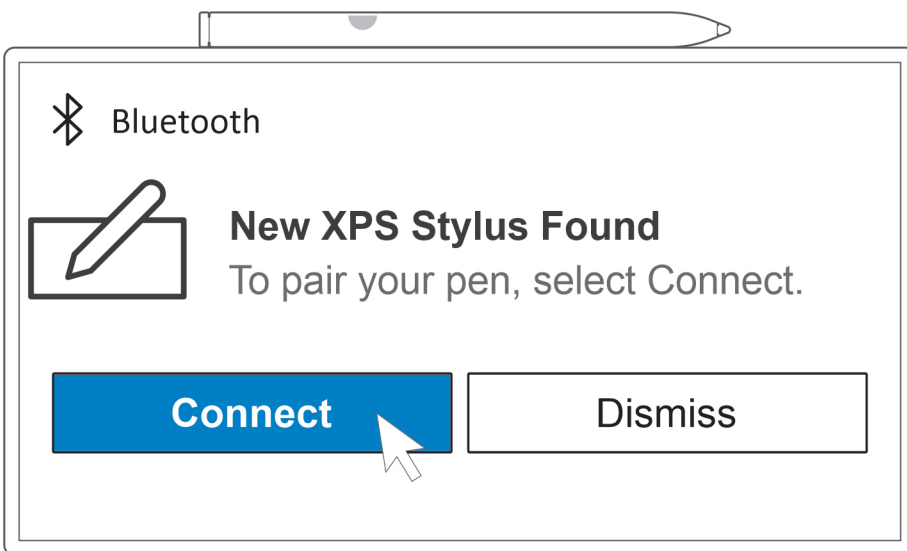

The LED indicator on your XPS Stylus starts blinking and turns solid blue after pairing is successfully complete. After successful pairing, your computer and pen connect automatically when Bluetooth is enabled and are within the Bluetooth range.

**NOTE:** For more information on the XPS Stylus, refer to the *XPS Stylus User's Guide* available with your product documentation at [www.dell.com/support](http://www.dell.com/support).



## Views of XPS 13 9315 2-in-1

### Front



- 1. Left microphone**  
Provides digital sound input for audio recording and voice calls.
- 2. Infrared camera**  
Enhances security when paired with Windows Hello face authentication.
- 3. Infrared emitter**  
Emits infrared light, which enables the infrared camera to sense and track motion.
- 4. RGB Camera**  
Enables you to video chat, capture photos, and record videos.
- 5. Camera-status light**  
Turns on when the camera is in use.
- 6. Ambient-light sensor**  
The sensor detects the ambient light and automatically adjusts the keyboard backlight and display brightness.
- 7. Right microphone**  
Provides digital sound input for audio recording and voice calls.

## Back

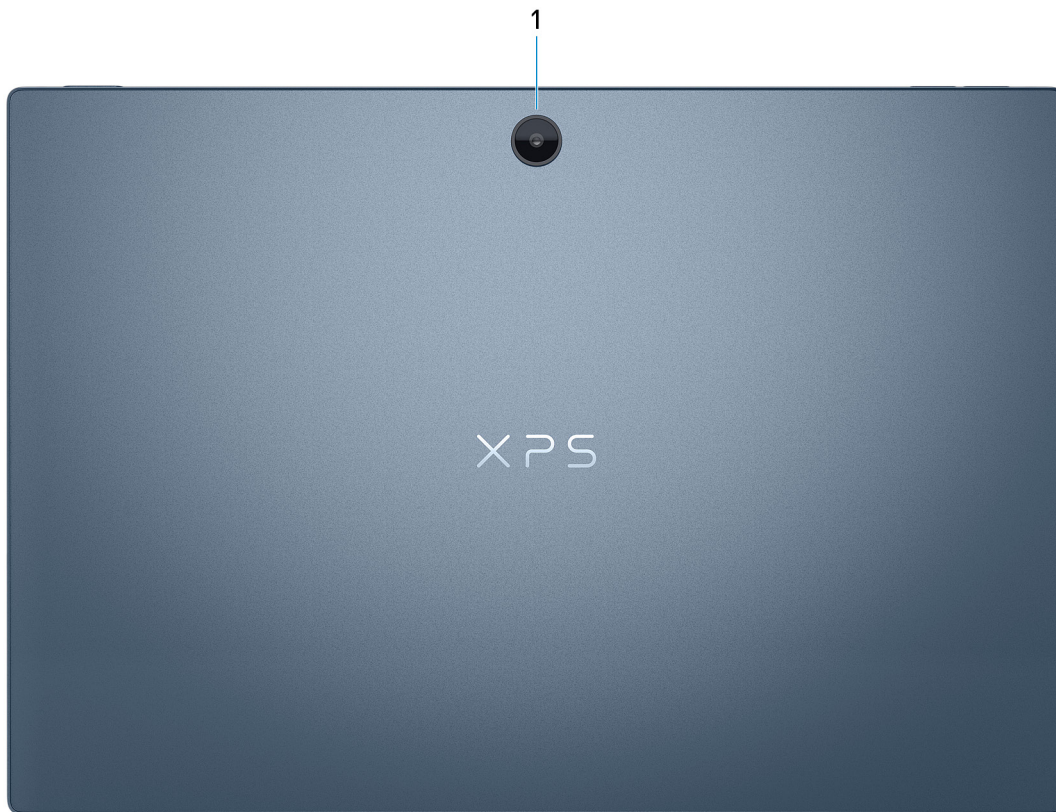

### 1. RGB Camera

Enables you to video chat, capture photos, and record videos.

## Right



### 1. Nano-SIM card slot

Insert a nano-SIM card to connect to a mobile broadband network.

**(i) NOTE:** This card slot is only available on computers that support WWAN.

**(i) NOTE:** WWAN support will be available at a later date.

### 2. Right speaker

Provides audio output.

## Left

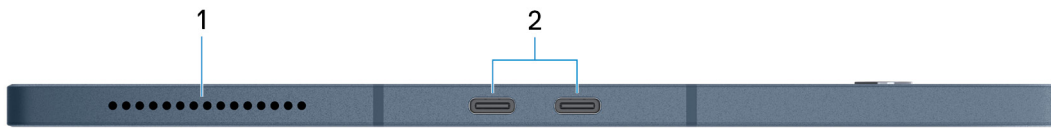

### 1. Left speaker

Provides audio output.

### 2. Thunderbolt 4.0 port with Power Delivery (2)

Supports USB4, DisplayPort 1.4, Thunderbolt 4 and also enables you to connect to an external display using a display adapter. Provides data transfer rates of up to 40 Gbps for USB4 and Thunderbolt 4.

**NOTE:** A USB Type-C to DisplayPort adapter (sold separately) is required to connect a DisplayPort device.

**NOTE:** USB4 is backward compatible with USB 3.2, USB 2.0, and Thunderbolt 3.

**NOTE:** Thunderbolt 4 supports two 4K displays or one 8K display.

**NOTE:** When both ports are in use for charging any devices, only one port delivers power of 5 V/3 A and the other port delivers 5 V/1.5 A.

**NOTE:** Either port can be used for charging your computer.

## Top

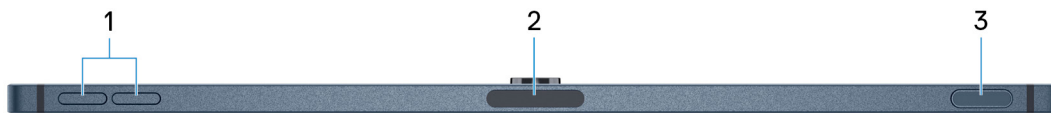

### 1. Volume-control buttons (2)

Press to increase or decrease the volume.

### 2. Charging pad for stylus

Allows you to charge the XPS Stylus (sold separately). Place the flat side of the stylus here after use.

### 3. Power button with fingerprint reader

Press to turn on the computer if it is turned off, in sleep mode, or in hibernate state.

When the computer is turned on, press the power button to put the computer into sleep state, press and hold the power button for 10 seconds to force shut-down the computer.

Place your finger on the power button to log in with the fingerprint reader.

**NOTE:** In Windows, Windows Hello supports a defined number of fingerprints per account. For more information about configuring your fingerprint reader with Windows Hello, search in the Knowledge Base Resource at [www.dell.com/support](http://www.dell.com/support).

# Bottom

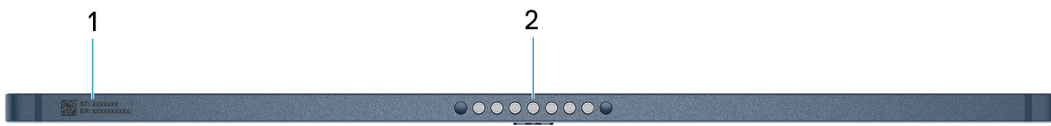

## 1. Service Tag label

The Service Tag is a unique alphanumeric identifier that enables Dell service technicians to identify the hardware components in your computer and access warranty information.

## 2. Pogo connector

Connect the computer to the XPS Folio keyboard (sold separately).

# Specifications of XPS 13 9315 2-in-1

## Dimensions and weight

The following table lists the height, width, depth, and weight of your XPS 13 9315 2-in-1.

**Table 2. Dimensions and weight**

Description	Values
Height:	<ul style="list-style-type: none"> <li>For computers with WWAN: 7.90 mm (0.31 in.)</li> <li>For computers with WLAN: 7.40 mm (0.29 in.)</li> </ul>
Width	292.50 mm (11.50 in.)
Depth	201.20 mm (7.90 in.)
Weight  <b>NOTE:</b> The weight of your computer depends on the configuration ordered and manufacturing variability.	<ul style="list-style-type: none"> <li>For computers with WWAN: 0.82 kg (1.81 lb)</li> <li>For computers with WLAN: 0.74 kg (1.62 lb)</li> </ul>

 **NOTE:** WWAN support will be available at a later date.

## Processor

The following table lists the details of the processors supported by your XPS 13 9315 2-in-1.

**Table 3. Processor**

Description	Option one	Option two
Processor type	12th Generation Intel Core i5-1230U	12th Generation Intel Core i7-1250U
Processor wattage	9 W	9 W
Processor total core count	10	10
Performance-cores	2	2
Efficient-cores	8	8
Processor total thread counts  <b>NOTE:</b> Intel® Hyper-Threading Technology is only available on Performance-cores.	12	12
Processor speed	0.7 to 4.4 GHz	0.8 to 4.7 GHz
Performance-cores frequency		
Processor base frequency	1.0 Ghz	1.1 Ghz
Maximum turbo frequency	4.4 Ghz	4.7 Ghz
Efficient-cores frequency		

**Table 3. Processor (continued)**

Description		Option one	Option two
	Processor base frequency	0.7 Ghz	0.8 Ghz
	Maximum turbo frequency	3.3 Ghz	3.5 Ghz
Thermal Mode/Thermal Design Power (TDP)			
	Cool	9 to 15 W	9 to 15 W
	Optimized	9 to 29 W	9 to 29 W
	Quiet	9 to 15 W	9 to 15 W
	Ultra Performance	9 to 29 W	9 to 29 W
 <b>NOTE:</b> Processor clock speeds and thermal design power differ according to the thermal mode selected in the My Dell app on your computer.			
	Processor cache	12 MB	12 MB
	Integrated graphics	Intel Iris Xe Graphics	Intel Iris Xe Graphics

## Chipset

The following table lists the details of the chipset supported by your XPS 13 9315 2-in-1.

**Table 4. Chipset**

Description	Values
Chipset	Integrated in processor
Processor	12th Generation Intel Core i5/i7
DRAM bus width	64-bit
Flash EPROM	64 MB
PCIe bus	Up to Gen 4

## Operating system

Your XPS 13 9315 2-in-1 supports the following operating systems:

- Windows 11 Pro, 64-bit
- Windows 11 Home, 64-bit

# Memory

The following table lists the memory specifications of your XPS 13 9315 2-in-1.

**Table 5. Memory specifications**

Description	Values
Memory slots	Onboard  <b>NOTE:</b> The memory is integrated on the system board and is not upgradeable.
Memory type	Dual-channel LPDDR4x
Memory speed	2133 MHz
Maximum memory configuration	16 GB
Minimum memory configuration	8 GB
Memory configurations supported	<ul style="list-style-type: none"><li>• 8 GB, 2 x 4 GB, Dual-Channel LPDDR4x, 2133 Mhz</li><li>• 16 GB, 2 x 8 GB, Dual-Channel LPDDR4x, 2133 Mhz</li></ul>

# External ports

The following table lists the external ports on your XPS 13 9315 2-in-1.

**Table 6. External ports**

Description	Values
USB ports	Two Thunderbolt 4 (Type-C) ports with Power Delivery  <b>NOTE:</b> When both ports are in use for charging any devices, only one port delivers power of 5 V/3 A and the other port delivers 5 V/1.5 A.

# Internal slots

The following table lists the internal slots of your XPS 13 9315 2-in-1.

**Table 7. Internal slots**

Description	Values
M.2	One M.2 2230 slot for solid-state drive  <b>NOTE:</b> To learn more about the features of different types of M.2 cards, search in the Knowledge Base Resource at <a href="http://www.dell.com/support">www.dell.com/support</a> .

## WLAN module

The following table lists the Wireless Local Area Network (WLAN) module supported on your XPS 13 9315 2-in-1.

**Table 8. WLAN module specifications**

Description	Values
Model number	Intel AX211
Transfer rate	Up to 2400 Mbps
Frequency bands supported	2.4 GHz/5 GHz/6 GHz
Wireless standards	<ul style="list-style-type: none"> <li>• WiFi 802.11a/b/g</li> <li>• Wi-Fi 4 (WiFi 802.11n)</li> <li>• Wi-Fi 5 (WiFi 802.11ac)</li> <li>• Wi-Fi 6E (WiFi 802.11ax)</li> </ul>
Encryption	<ul style="list-style-type: none"> <li>• 64-bit/128-bit WEP</li> <li>• AES-CCMP</li> <li>• TKIP</li> </ul>
Bluetooth	Bluetooth 5.3 wireless card

## WWAN module

The following table lists the Wireless Wide Area Network (WWAN) module supported on your XPS 13 9315 2-in-1.

- NOTE:** This module is only available on computers that support WWAN.
- NOTE:** WWAN support will be available at a later date.
- NOTE:** Availability of the eSIM feature on this module is dependent on your region and your mobile carrier's requirements.
- NOTE:** For instructions on how to setup SIM or eSIM connections on your computer, refer to the *SIM/eSIM Setup Guide for Windows* available with your product documentation at [www.dell.com/support](http://www.dell.com/support).
- NOTE:** For instructions on how to find your computer's IMEI (International Mobile Station Equipment Identity) number, search in the Knowledge Base Resource at [www.dell.com/support](http://www.dell.com/support).

**Table 9. WWAN module specifications**

Description	Values
Model number	DW5931e, Intel 5000 Global 5G Modem with eSIM option
Transfer rate	<ul style="list-style-type: none"> <li>• SA: DL 4.67 Gbps/UL 1.25 Gbps</li> <li>• NSA: DL 3.74 Gbps/UL 835 Mbps</li> <li>• LTE: DL 1.6 Gbps (CAT19)/UL 211 Mbps</li> <li>• UMTS: DL 384 kbps/UL 384 kbps DL DC-HSPA+: 42 Mbps (CAT24)/UL 11.5 Mbps (CAT7)</li> </ul>
Frequency bands supported	<ul style="list-style-type: none"> <li>• NR: n1, n2, n3, n5, n7, n8, n20, n25, n28, n30, n38, n40, n41, n48, n66, n71, n77, n78, n79</li> </ul>



**Table 9. WWAN module specifications (continued)**

Description	Values
	<ul style="list-style-type: none"> <li>• LTE :B1, B2, B3, B4, B5, B7, B8, B12, B13, B14, B17, B18, B19, B20, B25, B26, B28, B29, B30, B32, B34, B38, B39, B40, B41, B42, B43, B46, B48, B66, B71</li> <li>• WCDMA/HSPA+ : 1, 2, 4, 5, 8</li> </ul>
Wireless standards	<ul style="list-style-type: none"> <li>• NR FR1 (Sub6) FDD/TDD</li> <li>• LTE FDD/TDD</li> <li>• WCDMA/HSPA+</li> <li>• GPS/GLONASS/Galileo/BDS/QZSS</li> </ul>
Encryption	Not supported
Global Navigation Satellite System (GNSS)	Supports GPS, GLONASS, Galileo, BDS, and QZSS

## Audio

The following table lists the audio specifications of your XPS 13 9315 2-in-1.

**Table 10. Audio specifications**

Description	Values	
Audio controller	USB-C Digital Audio	
Stereo conversion	Supported	
Internal audio interface	Intel SoundWire	
External audio interface	Not supported	
Number of speakers	2	
Internal-speaker amplifier	Realtek ALC1319D	
External volume controls	Volume buttons	
Speaker output:		
	Average speaker output	2 W
	Peak speaker output	2.5 W
Subwoofer output	Not supported	
Microphone	Dual digital-array microphones	

## Storage

This section lists the storage options on your XPS 13 9315 2-in-1.

Your XPS 13 9315 2-in-1 supports one M.2 2230 solid-state drive.

**Table 11. Storage specifications**

Storage type	Interface type	Capacity
M.2 2230 solid-state drive	PCIe Gen4 x4 NVMe, up to 64 Gbps	Up to 1 TB

## Camera

The following table lists the camera specifications of your XPS 13 9315 2-in-1.

**Table 12. Camera specifications**

Description	Values
Number of cameras	Three
Camera type	<ul style="list-style-type: none"> <li>World-facing camera: RGB camera</li> <li>User-facing cameras: RGB and IR cameras</li> </ul>
Camera location	<ul style="list-style-type: none"> <li>World-facing camera</li> <li>User-facing camera (2)</li> </ul>
Camera sensor type	CMOS sensor technology
Camera resolution:	
Still image	<ul style="list-style-type: none"> <li>World-facing camera: 10 megapixel</li> <li>User-facing camera: 5 megapixel</li> </ul>
Video	<ul style="list-style-type: none"> <li>World-facing camera: 3840 x 2160 (4K) at 30 fps</li> <li>User-facing camera: 1920 x 1080 (FHD) at 30 fps</li> </ul>
Infrared camera resolution:	
Still image	0.3 megapixel
Video	640 x 480 at 60 fps
Diagonal viewing angle:	
Camera	<ul style="list-style-type: none"> <li>World-facing camera: 97 degrees</li> <li>User-facing camera: 92 degrees</li> </ul>
Infrared camera	77.3 degrees

## Power adapter

The following table lists the power adapter specifications of your XPS 13 9315 2-in-1.

**Table 13. Power adapter specifications**

Description	Values
Type	45 W Small Form Factor (USB Type-C)
Power-adapter dimensions:	
Height	22 mm (0.87 in.)
Width	55 mm (2.17 in.)

**Table 13. Power adapter specifications (continued)**

Description		Values
	Depth	60 mm (2.36 in.)
Input voltage		100 VAC–240 VAC
Input frequency		50 Hz–60 Hz
Input current (maximum)		1.3 A
Output current (continuous)		<ul style="list-style-type: none"> <li>● 20 V/2.25 A (Continuous)</li> <li>● 15 V/3 A (Continuous)</li> <li>● 9 V/3 A (Continuous)</li> <li>● 5 V/3 A (Continuous)</li> </ul>
Rated output voltage		<ul style="list-style-type: none"> <li>● 20 VDC</li> <li>● 15 VDC</li> <li>● 9 VDC</li> <li>● 5 VDC</li> </ul>
Temperature range:		
	Operating	0°C to 40°C (32°F to 104°F)
	Storage	-40°C to 70°C (-40°F to 158°F)
 <b>CAUTION: Operating and storage temperature ranges may differ among components, so operating or storing the device outside these ranges may impact the performance of specific components.</b>		

## Battery

The following table lists the battery specifications of your XPS 13 9315 2-in-1.

**Table 14. Battery specifications**

Description		Values
Battery type		3-cell, 49.5 Whr "smart" lithium-ion, ExpressCharge Boost
Battery voltage		11.40 VDC
Battery weight (maximum)		0.20 kg (0.44 lb)
Battery dimensions:		
	Height	230.20 mm (9.06 in.)
	Width	117.00 mm (4.61 in.)
	Depth	3.70 mm (0.15 in.)
Temperature range:		
	Operating	0°C to 45°C (32°F to 113°F)
	Storage	-20°C to 70°C (4°F to 158 °F)
Battery operating time		Varies depending on operating conditions and can significantly reduce under certain power-intensive conditions.

**Table 14. Battery specifications (continued)**

Description	Values
Battery charging time (approximate) <b>i</b> <b>NOTE:</b> Control the charging time, duration, start and end time, and so on using the Dell Power Manager application. For more information about Dell Power Manager, search in the Knowledge Base Resource at <a href="http://www.dell.com/support">www.dell.com/support</a> .	3 hours (when the computer is off)
Coin-cell battery	Not supported
<b>⚠ CAUTION: Operating and storage temperature ranges may differ among components, so operating or storing the device outside these ranges may impact the performance of specific components.</b>	
<b>⚠ CAUTION: Dell recommends that you charge the battery regularly for optimal power consumption. If your battery charge is completely depleted, connect the power adapter, turn on your computer, and then restart your computer to reduce the power consumption.</b>	

## Display

The following table lists the display specifications of your XPS 13 9315 2-in-1.

**Table 15. Display specifications**

Description	Values
Display type	3K Class 3:2, DisplayHDR 400, White Light Emitting Diode (WLED), Eyesafe Low Blue Light Display Technology, Gorilla Glass Victus
Display-panel technology	Wide Viewing Angle (WVA)
Display-panel dimensions (active area):	
Height	182.59 mm (7.19 in.)
Width	273.89 mm (10.78 in.)
Diagonal	330.20 mm (13.00 in.)
Display-panel native resolution	2880 x 1920
Luminance (typical)	500 nits
Megapixels	5.5
Color gamut	100% (sRGB)
Pixels Per Inch (PPI)	267
Contrast ratio (minimum)	1800:1
Response time (maximum)	35 ms
Refresh rate	60 Hz
Horizontal view angle	88 +/- degrees
Vertical view angle	88 +/- degrees

**Table 15. Display specifications (continued)**

Description	Values
Pixel pitch	0.095 mm
Power consumption (maximum)	3.34 W
Anti-glare vs glossy finish	Anti-reflection/Anti-smudge coating
Touch options	Yes
Stylus support	Yes

## GPU—Integrated

The following table lists the specifications of the integrated Graphics Processing Unit (GPU) supported by your XPS 13 9315 2-in-1.

**Table 16. GPU—Integrated**

Controller	Memory size	Processor
Intel Iris Xe Graphics	Shared system memory	12th Generation Intel Core i5/i7

## Fingerprint reader

The following table lists the fingerprint-reader specifications of your XPS 13 9315 2-in-1.



 **NOTE:** The fingerprint reader is located on the power button.

**Table 17. Fingerprint reader specifications**

Description	Values
Fingerprint-reader sensor technology	Capacitive
Fingerprint-reader sensor resolution	500 dpi
Fingerprint-reader sensor pixel size	54 x 176

## Sensors

**Table 18. Sensors**

Sensor support
Ambient Light Sensor
GPS (via WWAN card)  <b>NOTE:</b> WWAN support will be available at a later date.
Hall sensor  <b>NOTE:</b> The Hall sensor is located on the system board.

# Operating and storage environment

This table lists the operating and storage specifications of your XPS 13 9315 2-in-1.

**Airborne contaminant level:** G1 as defined by ISA-S71.04-1985

**Table 19. Computer environment**

Description	Operating	Storage
Temperature range	0°C to 35°C (32°F to 95°F)	-40°C to 65°C (-40°F to 149°F)
Relative humidity (maximum)	10% to 90% (non-condensing)	0% to 95% (non-condensing)
Vibration (maximum)*	0.66 GRMS	1.30 GRMS
Shock (maximum)	110 G†	160 G†
Altitude range	-15.2 m to 3,048 m (-49.87 ft to 10,000 ft)	-15.2 m to 10,668 m (-49.87 ft to 35,000 ft)
 <b>CAUTION: Operating and storage temperature ranges may differ among components, so operating or storing the device outside these ranges may impact the performance of specific components.</b>		

\* Measured using a random vibration spectrum that simulates user environment.

† Measured using a 2 ms half-sine pulse.

# Hardware security

The following table lists the hardware security of your XPS 13 9315 2-in-1.

**Table 20. Hardware security**

Hardware security
Trusted Platform Module (TPM) 2.0
Touch Fingerprint Reader (in Power Button) with Absolute Control (Optional)

# Keyboard

The following table lists the keyboard specifications of your XPS Folio keyboard (sold separately).

**Table 21. Keyboard specifications**

Description	Values
Keyboard type	XPS Folio keyboard
Keyboard layout	QWERTY
Number of keys	<ul style="list-style-type: none"> <li>● United States and Canada: 79 keys</li> <li>● United Kingdom: 80 keys</li> <li>● Japan: 83 keys</li> </ul>
Keyboard size	X=19.05 mm key pitch Y=18.05 mm key pitch

**Table 21. Keyboard specifications (continued)**

Description	Values
Keyboard shortcuts	<p>Some keys on your keyboard have two symbols on them. These keys can be used to type alternate characters or to perform secondary functions. To type the alternate character, press Shift and the desired key. To perform secondary functions, press Fn and the desired key.</p> <p><b>i</b> <b>NOTE:</b> You can define the primary behavior of the function keys (F1–F12) changing <b>Function Key Behavior</b> in BIOS setup program. For more information, see <a href="#">keyboard shortcuts</a>.</p>

## Touchpad

The following table lists the touchpad specifications of your XPS Folio keyboard (sold separately).

**Table 22. Touchpad specifications**

Description	Values
Touchpad resolution:	
Horizontal	1398 DPI
Vertical	907 DPI
Touchpad dimensions:	
Horizontal	114.00 mm (4.49 in.)
Vertical	74.20 mm (2.92 in.)
Touchpad gestures	For more information about touchpad gestures available on Windows, see the Microsoft knowledge base article at <a href="https://support.microsoft.com">support.microsoft.com</a> .

## Low blue light

 **WARNING: Prolonged exposure to blue light from the display may lead to long-term effects such as eye strain, eye fatigue, or damage to the eyes.**

Blue light is a color in the light spectrum which has a short wavelength and high energy. Chronic exposure to blue light, particularly from digital sources, may disrupt sleep patterns and cause long-term effects such as eye strain, eye fatigue, or damage to the eyes.

The display on this computer is designed to minimize blue light and complies with TÜV Rheinland's requirement for low blue light displays.

Low blue light mode is enabled at the factory, so no further configuration is necessary.

To reduce the risk of eye strain, it is also recommended that you:

- Position the display at a comfortable viewing distance between 20 and 28 inches (50 and 70 cm) from your eyes.
- Blink frequently to moisten your eyes, wet your eyes with water, or apply suitable eye drops.
- Look away from your display, and gaze at a distant object at 20 ft (609.60 cm) away for at least 20 seconds during each break.
- Take an extended break for 20 minutes every two hours.



## Keyboard shortcuts of XPS Folio keyboard

**NOTE:** The XPS Folio keyboard is sold separately.

**NOTE:** Keyboard characters may differ depending on the keyboard language configuration. Keys that are used for shortcuts remain the same across all language configurations.

Some keys on your keyboard have two symbols on them. These keys can be used to type alternate characters or to perform secondary functions. The symbol that is shown on the lower part of the key refers to the character that is typed out when the key is pressed. If you press **shift** and the key, the symbol that is shown on the upper part of the key is typed out. For example, if you press **2**, **2** is typed out; if you press **Shift + 2**, **@** is typed out.

The keys **F1-F12** at the top row of the keyboard are function keys for multimedia control, as indicated by the icon at the bottom of the key. Press the function key to invoke the task represented by the icon. For example, pressing **F1** mutes the audio (see the table below).

However, if the function keys **F1-F12** are needed for specific software applications, multimedia functionality can be disabled by pressing **fn + esc**. Subsequently, multimedia control can be invoked by pressing **fn** and the respective function key. For example, mute audio by pressing **fn + F1**.

**NOTE:** You can also define the primary behavior of the function keys (**F1-F12**) by changing **Function Key Behavior** in BIOS setup program.

**Table 23. List of keyboard shortcuts**

Function key	Re-defined key (for multi-media control)	Behavior
F1	fn + F1	Mute audio
F2	fn + F2	Decrease volume
F3	fn + F3	Increase volume
F4	fn + F4	Mic mute
F5	fn + F5	Play/Pause
F6	fn + F6	Keyboard backlight <b>NOTE:</b> Toggle to cycle the keyboard backlight status through off, low-backlight, and high-backlight
F7	fn + F7	Decrease brightness
F8	fn + F8	Increase brightness
F9	fn + F9	Switch to external display
F10	fn + F10	Print screen
F11	fn + F11	Home
F12	fn + F12	End

The **fn** key is also used with selected keys on the keyboard to invoke other secondary functions.

**Table 24. List of keyboard shortcuts**

Function key	Behavior
fn + arrow left	Home
fn + arrow right	End

**Table 24. List of keyboard shortcuts (continued)**



<b>Function key</b>	<b>Behavior</b>
fn + B	Pause/Break
fn + right ctrl + B	Break
fn + left ctrl + B	ctrl + Break
fn + S	Toggle scroll lock
fn + R	System request
fn + esc	Toggle fn-key lock
fn + arrow up	Page up
fn + arrow down	Page down

# Getting help and contacting Dell

## Self-help resources

You can get information and help on Dell products and services using these self-help resources:

**Table 25. Self-help resources**

Self-help resources	Resource location
Information about Dell products and services	<a href="http://www.dell.com">www.dell.com</a>
My Dell app	
Tips	
Contact Support	In Windows search, type <code>Contact Support</code> , and press Enter.
Online help for operating system	<a href="http://www.dell.com/support/windows">www.dell.com/support/windows</a>
Access top solutions, diagnostics, drivers and downloads, and learn more about your computer through videos, manuals and documents.	Your Dell computer is uniquely identified by a Service Tag or Express Service Code. To view relevant support resources for your Dell computer, enter the Service Tag or Express Service Code at <a href="http://www.dell.com/support">www.dell.com/support</a> .  For more information on how to find the Service Tag for your computer, see <a href="#">Locate the Service Tag on your computer</a> .
Dell knowledge base articles for a variety of computer concerns	<ol style="list-style-type: none"> <li>1. Go to <a href="http://www.dell.com/support">www.dell.com/support</a>.</li> <li>2. On the menu bar at the top of the Support page, select <b>Support &gt; Knowledge Base</b>.</li> <li>3. In the Search field on the Knowledge Base page, type the keyword, topic, or model number, and then click or tap the search icon to view the related articles.</li> </ol>

## Contacting Dell

To contact Dell for sales, technical support, or customer service issues, see [www.dell.com/contactdell](http://www.dell.com/contactdell).

 **NOTE:** Availability varies by country/region and product, and some services may not be available in your country/region.

 **NOTE:** If you do not have an active Internet connection, you can find contact information about your purchase invoice, packing slip, bill, or Dell product catalog.